

# Connect

4K Wireless Conferencing System

## Quick Start Guide

**Connect** is an all-in-one wireless conferencing system designed to simplify your meetings. With full BYOD support, it allows you to effortlessly connect your laptop to the speakerphone using a single cable. Enjoy 4K wireless screen casting, access to conference camera streaming in 1080P, and the convenience of plug-and-play functionality without the need for software or drivers.

Connect streamlines your conferencing experience, eliminates cable clutter, and ensures secure and efficient collaboration.

### Package Contents

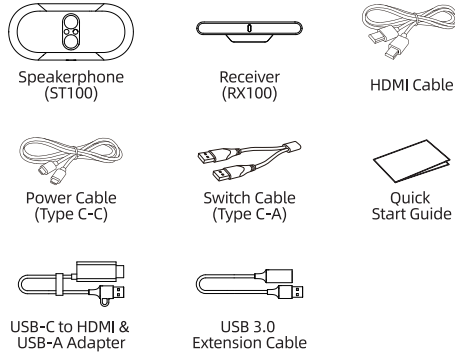

## Getting Started with Connect

(1) Connect the RX100 receiver to the display using the power cable and HDMI cable. If the display does not have a Type-C port to support power more than 5V/2A, use the included switch cable to convert it into two USB-A connectors. One of the USB-A connectors should be USB3.0, which can supply power for the receiver. Alternatively, you can connect the Type-C cable to a power adapter (not included in the package).

(2) To connect a USB webcam, plug the camera's USB cable into the USB-A port on the receiver.

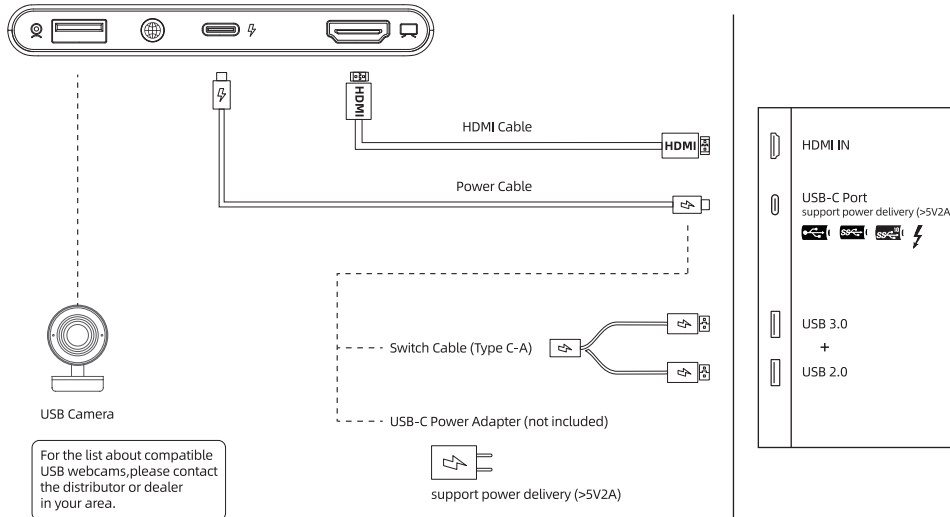

For the list about compatible USB webcams, please contact the distributor or dealer in your area.

support power delivery (>5V2A)

## Overview

### ST100

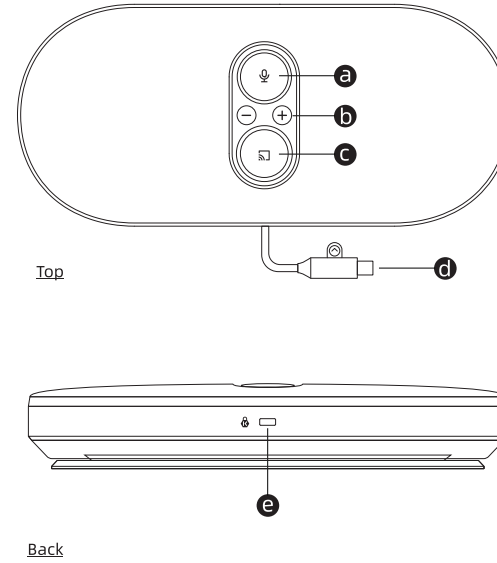

### RX100

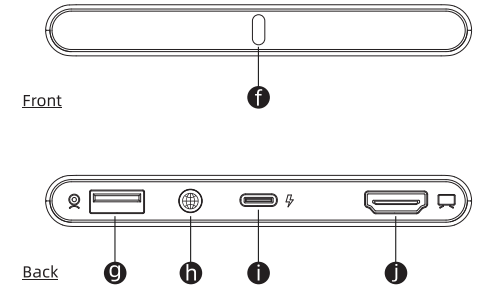

- a** Mic Mute  
Green light : Mic On  
Red light : Mic off
- b** Speaker Volume
- c** Screencast  
Press to start/end screencasting
- d** Type C cable to laptop  
For power supply and signal transmission
- e** Kensington Nano Slot
- f** Status Indicator
- g** USB Interface for camera (5V 0.9A)
- h** Language / Pair  
Short press : switch language  
Long press : Re-pair
- i** Power Supply
- j** HDMI Out for display

(3) Mount the receiver RX100 on the display using the built-in mounting clip. Ensure that the receiver is positioned towards the front side for optimal wireless signal transmission. The optimal wireless transmission range is within 5 meters.



(4) Switch the display output source to the connected HDMI port.



(5) Connect the speakerphone ST100 to a full-featured Type-C port on your laptop. Wait until the screencasting button light turns green, then press the button to start casting your screen. Press the button again to pause screencasting.

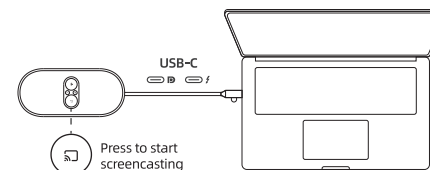

**\* In the case where the laptop's type C port does not meet the full feature requirement, use the USB-C to HDMI & USB-A Adapter instead.**

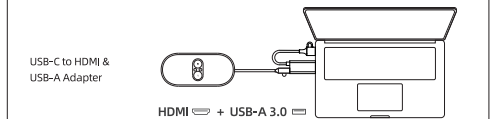

**\* Use the USB 3.0 Extension Cable if the laptop's USB3.0 port is not nearby the HDMI port.**

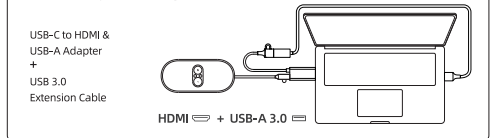

(6) To use the speakerphone ST100 and access the camera wirelessly, in your video conference software, select "Connect Video Device" as your microphone, speaker, and camera.

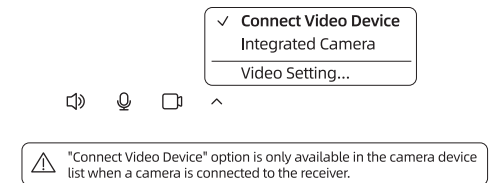

## Status Indicators

### Speaker (ST100)

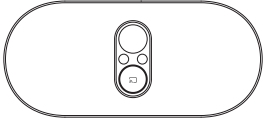

Flashing Green	Connecting in progress.
Static Green	Connection succeed, ready for screencasting.
Static Yellow	No DP signal from the laptop port.
Static Red	Connection failed: 1. Replug the speakerphone ST100 2. The receiver RX100 is not powered, please replug and ensure the RX100 indicator light shows static white. 3. The RX100 and ST100 are not paired. Please ensure they are the original paired units. Otherwise please re-pair.

### Receiver (RX100)



Flashing Green	Connection in progress.
Static Green	Connection succeed, ready for screencasting.
Static White	Power on and stand by.

## Specifications

### Microphone

Built-in Microphone	8 MEMS Microphone for 360-degree pickup
Pick-up Distance	4 m
Signal/Noise Ratio (SNR)	94dB SPL@1KHz 65dB(A)
Sensitivity	94dB SPL@1KHz -37±1dB FS
Acoustic Overload Point	132.5dB FS, 10%THD@1KHz
Frequency	20Hz - 8000Hz
Duplex	V
Beamforming	V
Automatic Noise Suppression	V
Acoustic Echo Cancellation	V
Automatic Gain Control	V

### Speaker

Speaker	4Ω3W
Speaker Size	50mm
Sensitivity	1KHz B3dB + 3dB @1m @3W
Signal/Noise Ratio (SNR)	50dB
Frequency Range	200Hz~20KHz
Max. Sound Pressure Level	88dB SPL @1m @3W
Background Noise	<30dB
Total Harmonic Distortion	200Hz ~ 10KHz MAX 5%

### Camera Streaming

Max. Output Resolution	1920x1080 @30FPS
Support Camera Type	UVC camera
Format Supported	H.264

### Screen Casting

Max. Screen Output Resolution	3840x2160 @30FPS
Average Latency	150ms

### Wi-Fi

Protocol	802.11 a/n/ac
Wireless Transmission Protocol	Quick UDP Internet Connections
Transmission Distance	Up to 10M
Frequency bands and the maximum transmitted power (for EU)	5180-5320MHz (Wi-Fi 5GHz),Max 23dBm 5500-5700MHz (Wi-Fi 5GHz),Max 23dBm (Support TPC)
RF Software Version:	3.0.1
RF Hardware Version:	1.0.0

### Others

I/O Interface	Speakerphone (ST100) : Type C PD + DP ALT Receiver(RX100) : HDMI x1; TYPE C PD ; USB A 3.0
Operating System	Win 10/ 11; Mac 10.8 and Later
Product Dimensions	Speakerphone (ST100): 180 x 81 x 32mm / 7.09 x 3.19 x 1.26" Receiver (RX100): 102 x 45 x 20mm/ 4.02 x 1.77 x 0.79"
Product Weights	Speakerphone (ST100): 385g / 13.58oz Receiver (RX100): 70g / 2.47oz
Package Contents	Connect: speakerphone(ST100) and receiver(RX100), 1.5m Type-C to Type-C cable, 1.5m HDMI Cable, 0.3m USB switch cable USB-C to HDMI & USB-A Adapter USB 3.0 Extension Cable

## USB Type-C Specification Table

USB-C Connector	Data Transfer	Display	Power	
USB 2.0 480 Mbps	Normal	O	X	X
	PD Enabled	O	X	O
USB 3.1 Gen 1 5 Gbps	Normal	O	X	X
	PD Enabled	O	X	O
USB 3.1 Gen 2 10 Gbps	Normal	O	X	X
	PD Enabled	O	X	O
DisplayPort 5-10 Gbps	Normal	O	O	X
	PD Enabled	O	O	O
Thunderbolt 20-40 Gbps PD Enabled DisplayPort		O	O	O

## Regulatory and Service Information

The products documented in this guide include aspects which are protected under their respective patent, copyright, design copyright, registered design and trademark laws. All other trademarks remain the property of their respective owners. This guide is distributed online. It may only be reproduced for use within the institution in which the product is used. For use outside of your institution, no part of this guide may be reproduced, transmitted, stored in a retrieval system or translated into any other language without the prior permission of our company. Please note that the content in this guide is protected under copyright law. Although every care has been taken in the compilation of this guide, our company accepts no responsibility for errors or omissions, or for damages resulting from the use of information contained within this guide.

## Compliance

### United States of America

This equipment has been tested and found to comply with the limits for a Class B digital device, pursuant to part 15 of the FCC Rules. These limits are designed to provide reasonable protection against harmful interference when the equipment is operated in a commercial environment. This equipment generates, uses, and can radiate radio frequency energy and, if not installed and used in accordance with the instruction manual, may cause harmful interference to radio communications. Operation of this equipment in a residential area is likely to cause harmful interference in which case the user will be required to correct the interference at his own expense. Do not make any changes or modifications to the equipment.

5.15 to 5.25 GHz band, UNII devices will be restricted to indoor operations to reduce any potential for harmful interference to co-channel Mobile Satellite System (MSS) operations. RF Radiation Exposure Statement Caution : This Transmitter must be installed to provide a separation distance of at least 20 cm from all persons.

## Warning

This equipment has been tested and found to comply with the limits for a Class B digital device, pursuant to Part 15 of FCC Rules. These limits are designed to provide reasonable protection against harmful interference in a residential installation. This equipment generates, uses, and can radiate radio frequency energy. If not installed and used in accordance with the instructions, it may cause harmful interference to radio communications.

However, there is no guarantee that interference will not occur in a particular installation. If this equipment does cause harmful interference to radio or television reception, which can be determined by turning the equipment off and on, the user is encouraged to try and correct the interference by one or more of the following measures :

- Reorient or relocate the receiving antenna.
- Increase the distance between the equipment and the receiver.
- Connect the equipment to outlet on a circuit different from that to which the receiver is connected.
- Consult the dealer or an experienced radio/TV technician for help
- Any changes or modifications not expressly approved by the party responsible for compliance could void the user's authority to operate the equipment.

This device complies with part 15 of the FCC rules. Operation is subject to the following two conditions:

1. This device may not cause harmful interference
2. This device must accept any interference received, including interference that may cause undesired operation.

FCC ID : 2BB9P00001
Model No. : ST100
FCC ID : 2BB9P00002
Model No. : RX100

### Europe

We declare under our Sole responsibility that the Connect conforms to the essential requirements of European Union Directives 2014/53/EU Radio Equipment Directive (RED), 2014/30/EU Electromagnetic Compatibility Directive, 2014/35/EU Low Voltage Directive and 2011/65/EU Restriction of Hazardous Substances in Electrical and Electronic Equipment.



These devices comply with RF specifications when the device is used at 20 cm from your body



This device is restricted to indoor use when operating in the 5150-5350MHz frequency range in all EU/EFTA member states and Turkey.

### United Kingdom

We declare under our sole responsibility that the Connect conforms to the essential UKCA requirements 2016 No : 1091. Electromagnetic Compatibility regulations 2016, 2016 No : 1101 Electrical Equipment Safety Regulation 2016, 2017 No : 1206 The Radio Equipment Regulation 2017, and UK SI 2016 No : 1091, RoHS Restriction of the use of certain Hazardous Substances in Electrical and Electronic Regulations 2012 - UK SI 2012 No : 3032.



Waste Electrical and Electronic Equipment (WEEE)

For more information concerning the correct disposal of these products, please contact your reseller.

