

# **innex** cube

**AI 360° 4K Conference Cam**

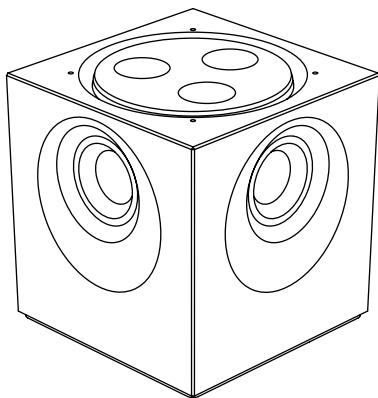

**Quick Start Guide**

**Innex Cube** is the world's smallest 4K 360° Conference Camera with built-in AI algorithms capable of tracking multiple people simultaneously. Creating the most immersive conference experience from the table center, Innex Cube captures video and audio from a close distance, at the eye-level from a natural forward angle. A patented real-time stitching algorithm technology stitches four high resolution sensors together to produce an ultra-clear and undistorted video. With built-in on screen display menu and a handy remote control, Innex Cube is truly plug and play and mobile.

Meet the future, all within the size of your hand.

## Package contents

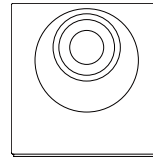

Innex Cube

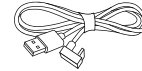

USB A-C Cable  
1.5m

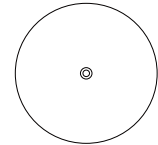

Wooden Base

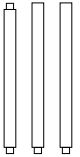

Poles x3



Visit FTI website to download multi-language quick start guide  
<https://funtechinnovation.com/downloads/>

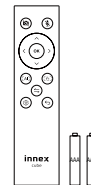

Remote Control  
AAA battery x2

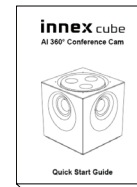

Quick Start Guide



Travel Box

## Overview

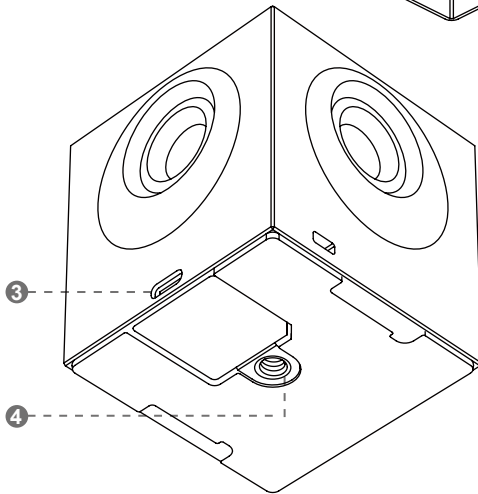
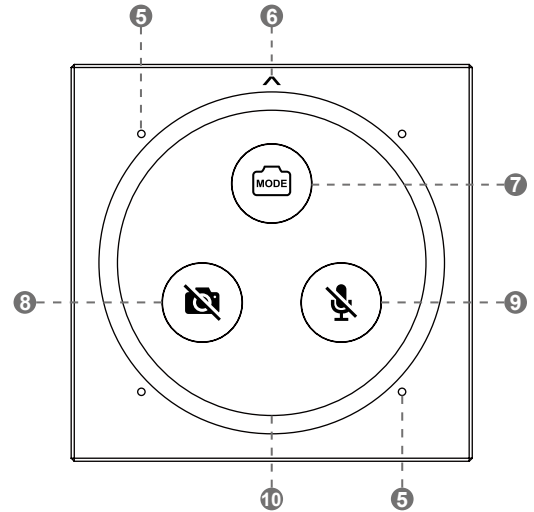
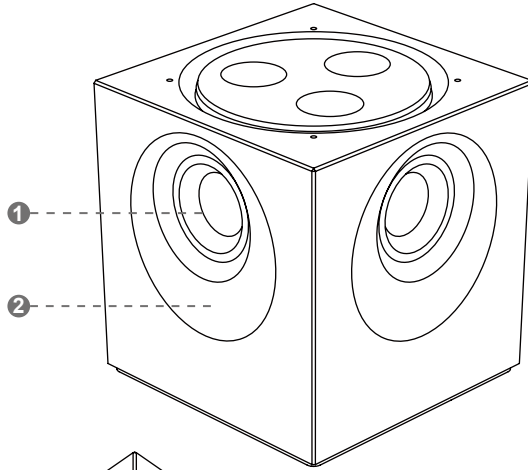

- 1 Cameras
- 2 IR Receivers
- 3 USB Type-C Port
- 4 1/4 Tripod Screw Hole
- 5 Microphones
- 6 Front Arrow
- 7 Mode Switch
- 8 Camera on/off
- 9 Microphone on/off

### 10 Status Indicator

Flashing white	Connecting to PC
LED off	Connection succeed
Static white	The camera is in use

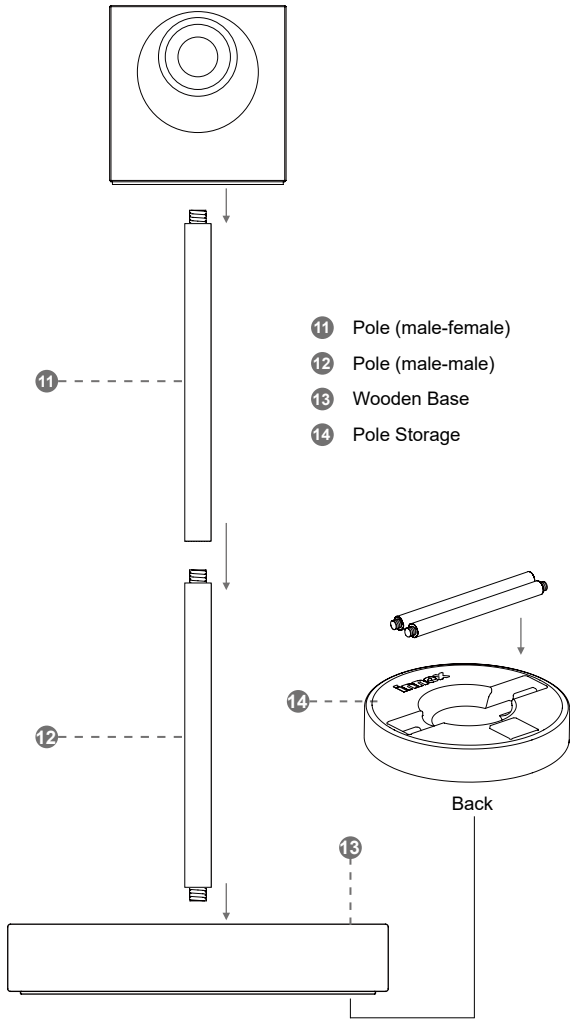

15 Additional Pole (male-female)

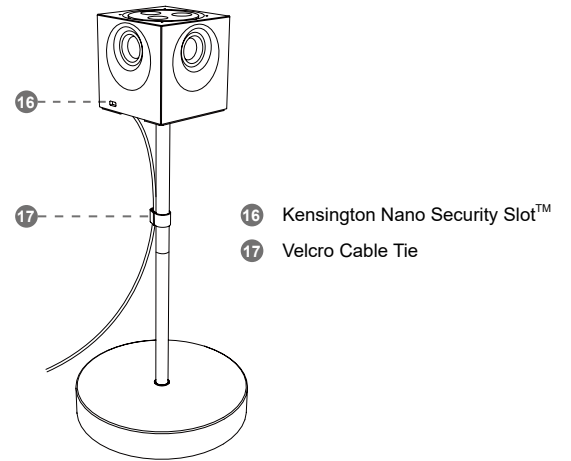
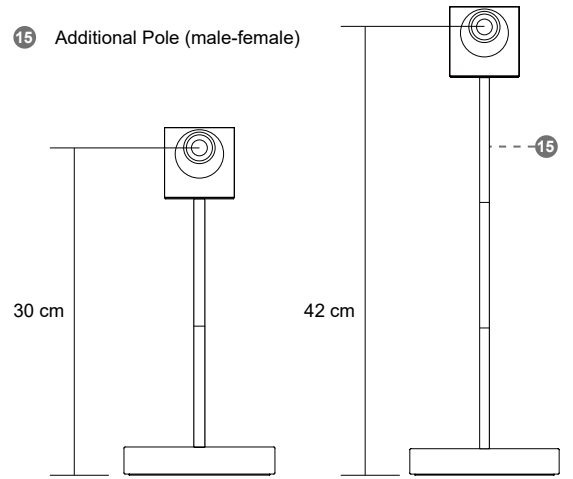

18 Remote Control

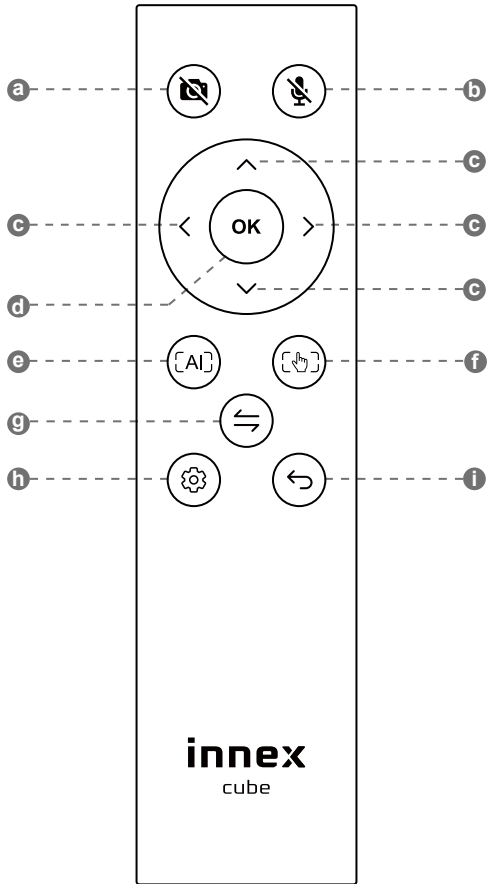

	Button	Description	Function
a		Camera on/off	Press to turn off and turn on the video
b		Microphone on/off	Press to mute and unmute the microphone
c		Arrow Keys	Adjust the position of the field of view
d	OK	Okay	Confirm
e	[AI]	AI mode	Cycle through AI modes
f		Manual mode	Cycle through Manual modes
g		Mirror	Mirror the text of on-screen display
h		Settings	Get into settings
i		Close	Close the settings

Notice: The typical response time of making commands is 1.6 seconds. Please allow sufficient response time when using the remote control.

## Getting started

1. Assemble Innex Cube with 2 or 3 poles.
2. Connect the USB cable. Plug the USB-C end to Innex Cube and USB-A end to a USB3.0 port of your computer.
3. Once the Cube is powered, the LED will start flashing. Wait until the LED is off before selecting Cube as camera in video conference software. When the Cube is selected as active camera, the LED will be on.
4. Point the Front Arrow toward the front of the meeting room where the display is usually located.
5. Press the Mode button on the camera or the buttons on the remote control to switch video modes. (By default, Cube starts in Gallery mode.)

Long press the camera's "MODE" button or short press the [AI] or [Hand] button on the remote control to switch between AI mode and Manual Mode.

In AI mode: Gallery / Auto-Framing / Stage modes.

In Manual mode: Conversation/ 360° Panorama / 270° / 180° / 120° / 90°.

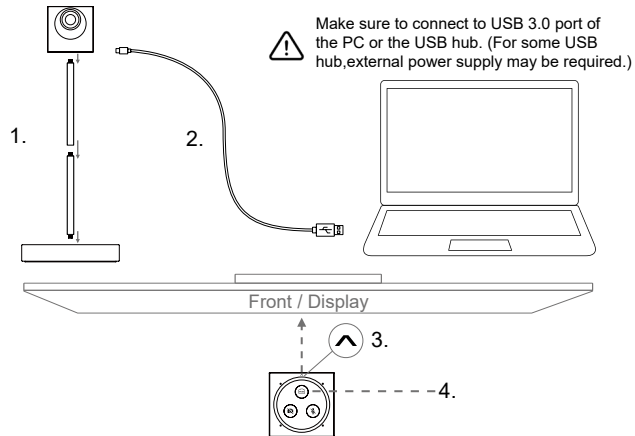

## Optimal AI Performance

With an effective coverage within a 2.5 meter detection radius and a number of 12 people, AI modes are recommended to be used in small-sized to medium-sized conference rooms. To use Cube in a large-sized conference room, it is recommended to use Manual modes for the best experience.

Cube's AI uses an advanced algorithm to optimize its detection and its positioning of people's upper body to better include people's hand gestures which is as important as their faces.

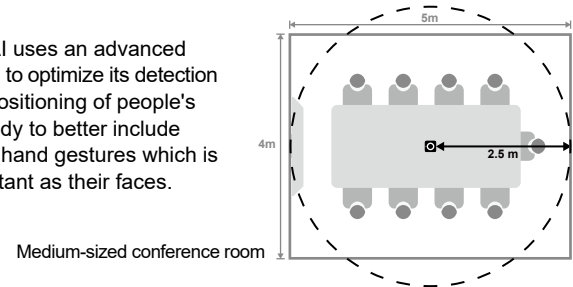

## Display Ignore

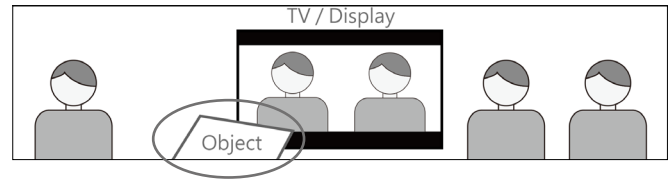

The AI is trained to automatically ignore people appearing in a display. However, it works best when the Cube gets a clear, unobstructed line of sight on the display. Any object or person that partially blocks and alternates display's rectangular shape can lower the AI's success rate.

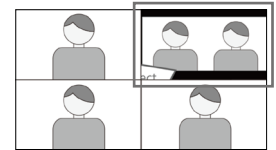

# Mirror Text Function

The default camera image is set to "mirrored" in some video conference software and will render the text of Innex Cube's On Screen Display (OSD) unreadable.

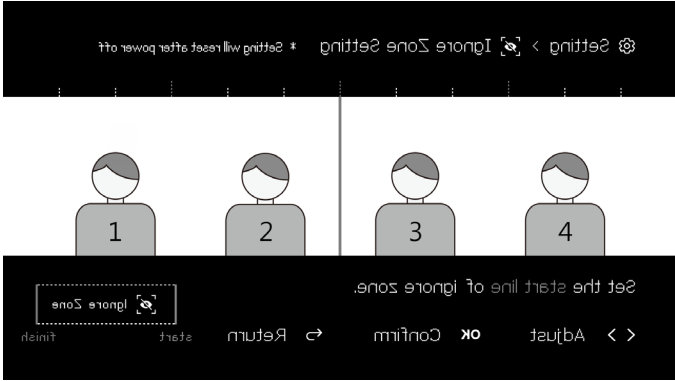

When the text of the OSD is mirrored, press the "⇌" button to mirror the text back. \*Please note that the camera image will not be mirrored.

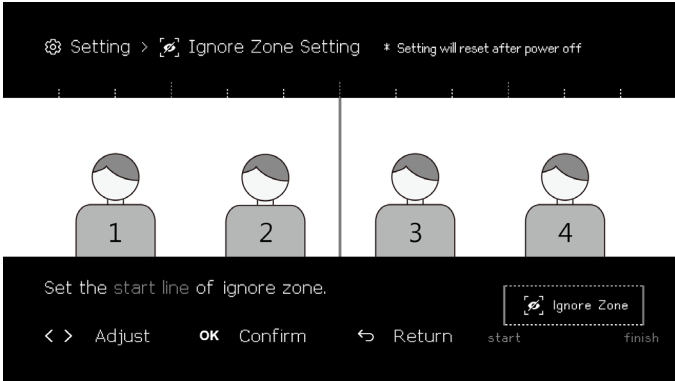

# Video Modes

## AI Gallery

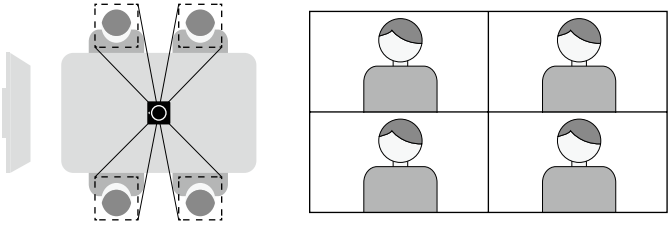

Gallery mode creates a close-up shot (a box) for each person. If two or more people are sitting close to each other, they will be merged into the same box. While capable of detecting up to 12 people at once, the maximum number of boxes are limited to 8. When no person is detected, a 360° panorama will be displayed.

( Gallery mode is always the default mode when the Cube is turned on. It is also the default AI mode when user switch to AI by pressing "Mode" on the camera and "AI" on the remote control )

## AI Auto-framing

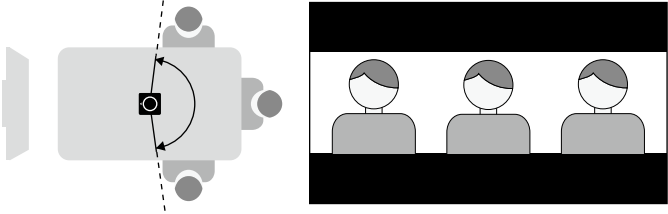

Auto-framing mode frames up to 12 people in the center of the view and trims off excess spaces on both sides. When no person is detected, a 360° panorama will be displayed.

### AI Stage

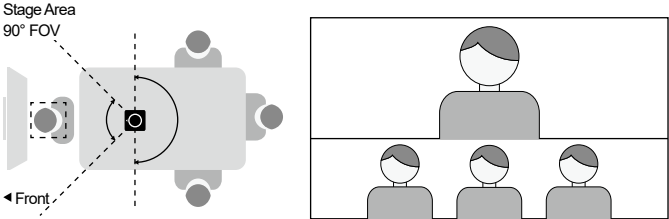

Stage mode auto-frames the presenter(s) in the stage area (area that is 180° centered on front arrow direction) and displays it at the upper portion while showing the back 180° side at the lower portion. The presenter(s) needs to stay within 2.5M AI detection radius in order to be tracked or auto-framed. When there's only one presenter in the stage area, he or she will be tracked within a 90° viewing angle. When there are multiple presenters in the stage area, they will be auto-framed and the distance between them determines the viewing angle which can be between 90° to 180°. When no person is detected in the stage area, two equal sized 180° views of the front and back side will be displayed.

### Manual Conversation

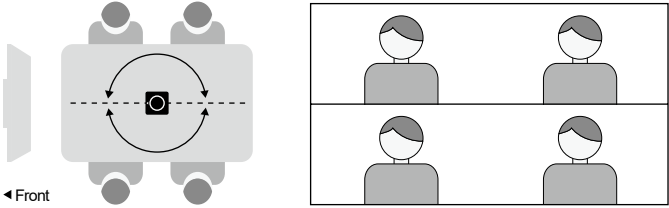

With the camera facing front (front arrow direction), Conversation splits participants from two sides into two equal 180° views. (Note: AI is not available under this mode.)

### Manual 360° Panorama

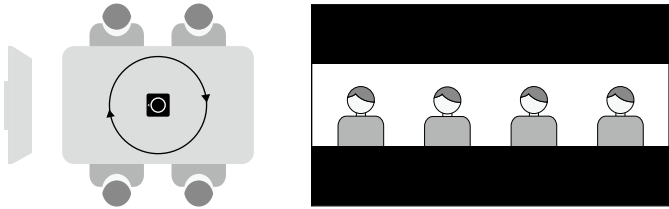

360° Panorama shows a full 360-degree view. Press "< >" to E-pan left or right to move the center of the 360° Panorama if required. (Note: AI is not available under this mode)

### Manual 270°/ 180°/ 120°/ 90°

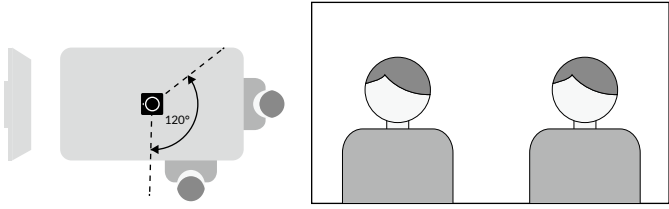

Customize the field of view with 4 preset viewing angles. Press "⇌" to rotate through view angles from 270° to 90° and use "⬅➡" to move the frame in the desired direction. (Note: AI is not available under this mode.)



In the Manual modes, users can conveniently control the FoV and the direction of the video. Below is the summary of the available control in the different modes.

Manual Mode	E-Pan Left / Right	E-Tilt Up/Down
Conversation	O	O
360°	O	X
270°	O	X
180°	O	X
120°	O	O
90°	O	O

## Best Setup Examples

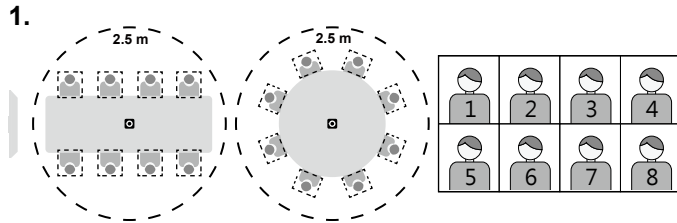

**Room Size:** Small to Medium.  
**Table Type:** Round or rectangular.  
**Participants:** No more than 8. Scattered sitting. Eyes on each other more.

**Suggested practice** - Capture individual close up shots.  
**Modes:** AI - Gallery mode.  
**Camera Position:** Center of the table.

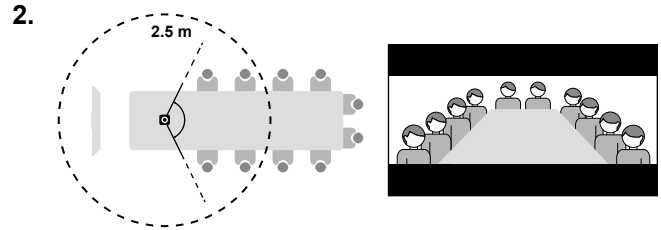

**Room Size:** Medium to Large.  
**Table Type:** Rectangular long table.  
**Participants:** 8 to 12. Sitting vertically to the display. Eyes on the display more.

**Suggested practice** - Capture group shots.  
**Modes:** AI - Auto-framing mode Or Manual 120°.  
**Camera Position:** Toward the front of the table.

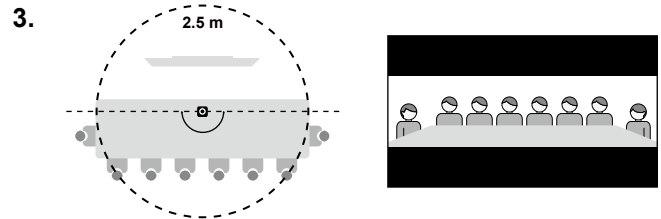

**Room Size:** Medium to Large.  
**Table Type:** Rectangular long table.  
**Participants:** 8 to 12. Sitting horizontally to the display. Eyes on the display more.

**Suggested practice** - Capture group shots.  
**Modes:** Manual 180° (AI auto-framing is not recommended as the person on the side is out of 2.5M range.)  
**Camera Position:** Toward the front of the table.

4.

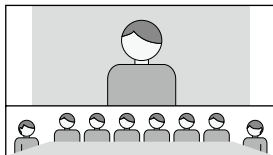
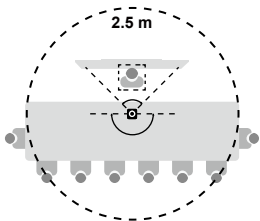

**Room Size:** Medium to Large.

**Table Type:** Rectangular long table.

**Participants:** 8 to 12. Sitting horizontally to the display. Eyes on the presenter more.

**Suggested practice** - Emphasize on presenter and show audience simultaneously.

**Modes:** AI - Stage mode.

**Camera Position:** Toward the front of the table.

5.

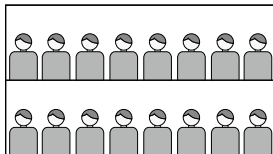
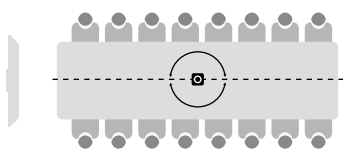

**Room Size:** Large or boardroom.

**Table Type:** Rectangular long table.

**Participants:** More than 12. Sitting vertically to the display, Eyes on each other more.

**Suggested practice** - Capture 2 groups from the middle.

**Manual** - Conversation mode. (AI mode is not recommended as it's over 12 people)

**Camera Position:** Middle of the table.

## Settings

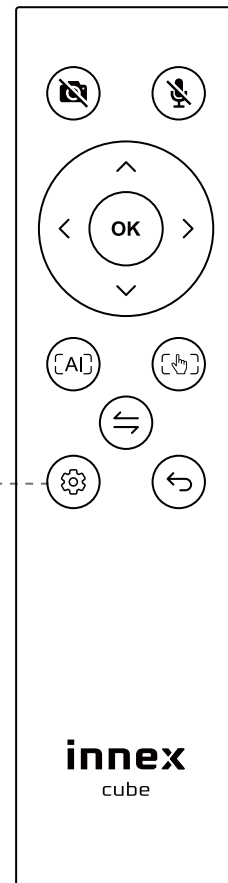

### Settings

AI Setting

Ignore Zone Setting

Language

About

**innex**  
cube

## AI Setting

Set the AI behavior between "Tracking" or "Track On Demand".  
 "Tracking" is always the default setting when the Cube is turned on.

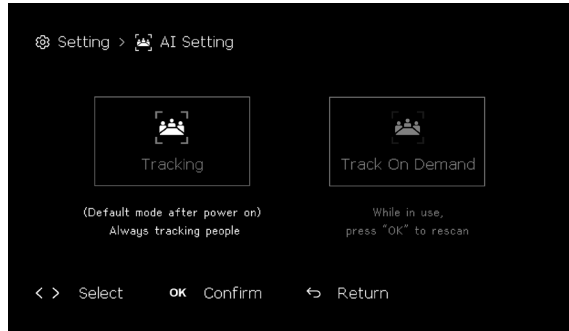

### Tracking

Set to "Tracking", AI will keep scanning and tracking people in all AI modes.  
 The AI response time is about 4-5 seconds when it is set to "Tracking"

### Track on Demand

To prevent interference resulting from people constantly moving, use the ">" arrow to select "Track on Demand" to disable auto-tracking. This will lock the Cube and prevent any person's movement from changing the Cube's output. An icon  will appear on the screen during the AI modes as a reminder. Once "Track On Demand" is selected, it will apply to all AI modes. Under this setting, pressing the "OK" button on the remote control will trigger a one-time AI scan. The AI response time is about 2.5 seconds when it is set to "Track On Demand".

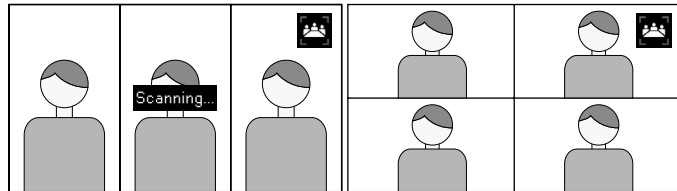

Press "OK" to trigger AI scan

After scanning

## Ignore Zone Setting

Select an area to disable AI detection to prevent unnecessary distractions or maintain privacy.  
 When an ignore zone is set, an icon  will appear on the screen during the AI modes as a reminder. (Ignore zone setting will reset after power off.)

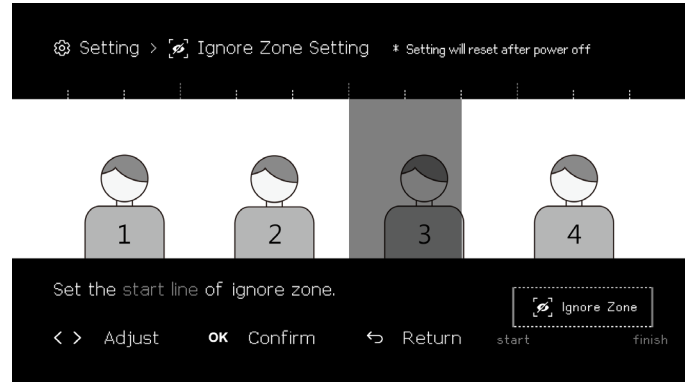

### Apply Ignore Zone Under the AI Modes

### Gallery

When the Ignore Zone is set, under Gallery mode, Innex Cube will not detect the participants who sit in that area of the room.

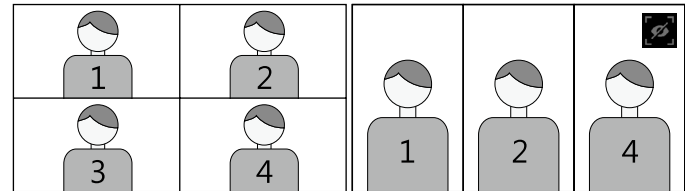

Original

With Ignore Zone Setup

## Auto-Framing

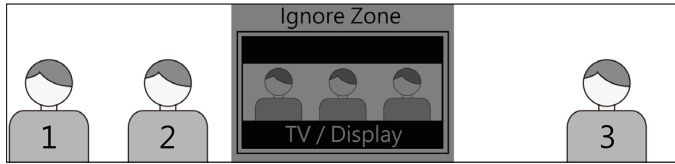

When the ignore zone is set, under Auto-Framing mode, Innex Cube will keep that area out of the frame.

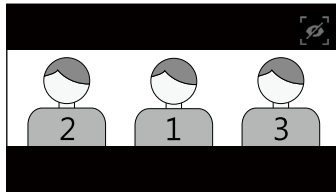

With Ignore Zone Setup

## Stage

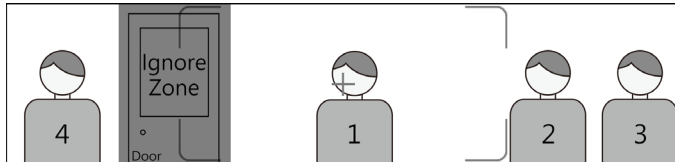

When the Ignore Zone is set within Stage Area, under Stage mode, Innex Cube will not display that area in the upper screen. If the Ignore Zone is set within the back 180° side, the ignore Zone will not work, as the bottom side is not using AI.

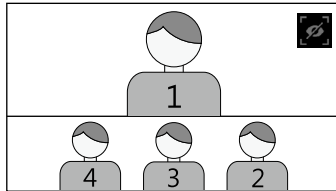

With Ignore Zone Setup

## Language

Switch and select the desired language.

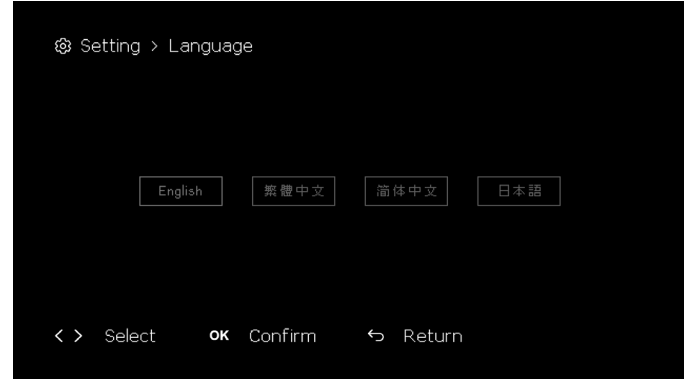

## About

Check the serial number and firmware version of the Innex Cube. Or restore factory settings.

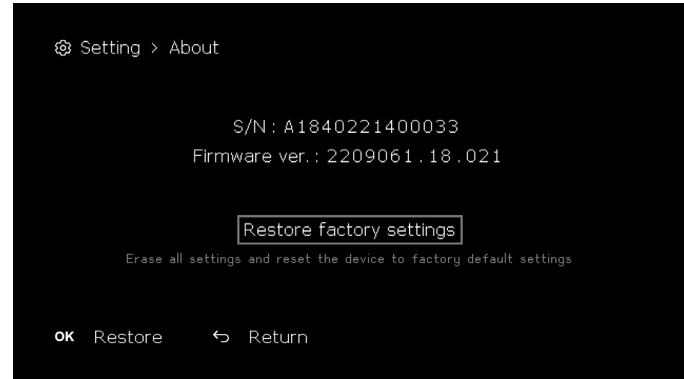

## Specifications

Camera	
Lens Resolution	5 Megapixels
Lens Quantity	4
Sensor	1/2.7" CMOS
Stitching Technology	Dynamic Real-Time Stitching Technology
Max. Resolution & Frame Rate	3840x964 @30fps (360°Panorama)
Focus Distance	2.3ft / 70cm
Max. Output Field of View	Horizontal 360° / Vertical 90°
Flicker	50Hz / 60Hz
Auto Exposure	Yes
Auto White Balance	Yes
Camera Embedded Mode	<ol style="list-style-type: none"> <li>1. Gallery</li> <li>2. Stage Mode</li> <li>3. Conversation Mode</li> <li>4. Auto-Framing</li> <li>5. Manual Mode 360°/270°/ 180°/ 120°/90°</li> </ol>
Microphone	
Microphone	2 Omnidirectional Microphones
Automatic Gain Control (AGC)	Yes
Active Noise Supression (ANS)	Yes
Sensitivity	-26dB FS
Pick-up Distance	10ft / 3m

Others	
Power Consumption	5V / 900mA
Interface of MIC & Camera	USB Type-C x1
Dimension	Cube: 65x65x66mm Pole: 122mm Wooden Base: 26x138Φmm Full Height: 208mm(1 Pole) / 324mm(2 poles) / 440mm(3 Poles) Travel Box: 235x108x165mm
Weight	Cube: 260g Wooden Base: 345g Poles: 70g (for x3)
Package Contents	Cube, USB Cable(1.5m), Pole x3, Wooden Base, Remote Control, Battery x2 (for Remote Control), Travel Box

## Important Safety, Compliance and Warranty Information

\*Read Manual Before Product Use\*



### POWER SUPPLY WARNING!

The power supply is for indoor use only. Only use the power supply included with your product. Do not attempt to repair or use a damaged power supply. Do not immerse the power supply in water or subject it to physical abuse. Inspect the power supply regularly for cable, plug, and casing damage.

### BATTERY WARNING!

Improperly replaced batteries may present a risk of leak or explosion and personal injury. Mistreated rechargeable batteries may present a risk of fire or chemical burn. Do not disassemble or expose to conducting materials, moisture, liquid, or heat above 54° C (130° F). Do not use or charge the battery if it appears to be leaking, discolored, deformed, or in any way abnormal. Do not leave your battery discharged or unused for extended periods. Do not short circuit. Your device may contain an internal, rechargeable battery that is not replaceable. Battery life varies with usage. Non-operational batteries should be discarded according to local laws. If no laws or regulations govern, dispose of your device in a waste bin for electronics. Keep batteries away from children.

### Safe Usage Guidelines for Products

- Do not open or modify the product except for battery removal and replacement.
- Do not disassemble or attempt to service this product.
- This product is safe under normal and reasonably foreseeable misuse operating conditions.
- If product is operating improperly, contact the authorized reseller.
- Product must be returned to the authorized reseller for any service or repair.
- This is not a Children's Product and is not intended for use by children under 14 years old.

### FunTech Innovation Compliance.

For Product Safety, EMC, RF and Energy information, go to [www.funtechinnovation.com/compliance](http://www.funtechinnovation.com/compliance) Maintenance is not required for product compliance. This product complies with relevant legal requirements for Restriction of Hazardous Substances (RoHS) and management of waste electronic and electrical equipment (WEEE). For RoHS and WEEE information, go to [www.funtechinnovation.com/compliance](http://www.funtechinnovation.com/compliance)



Batteries, electronic and electrical equipment should not be disposed of with household waste. Wherever possible, they should be segregated and brought to an appropriate collection point to enable recycling and avoid potential impacts on the environment and human health. For more information, contact your local authorities or place of purchase.

### FCC Statement

This device complies with Part 15 of the FCC Rules. Operation is subject to the following two conditions: 1) this device may not cause harmful interference, and 2) this device must accept any interference received, including interference that may cause undesired operation. This equipment has been tested and found to comply with the limits for a Class B digital device, pursuant to part 15 of the FCC Rules. These limits are designed to provide reasonable protection against harmful interference in a residential installation. This equipment generates, uses and can radiate radio frequency energy. And, if not installed and used in accordance with the instructions, may cause harmful interference to radio communications. However, there is no guarantee that interference will not occur in a particular installation. If this equipment does cause harmful interference to radio or television reception, which can be determined by turning the equipment off and on, the user is encouraged to try to correct the interference by one or more of the following measures:

- Reorient or relocate the receiving antenna.
- Increase the separation between the equipment and receiver.
- Connect the equipment into an outlet on a circuit different from that to which the receiver is connected.
- Consult the dealer or an experienced radio/TV technician for help.

Warning: Where shielded interface cables or accessories have been provided with the product or specified additional components or accessories elsewhere defined to be used with the installation of the product, they must be used in order to ensure compliance with FCC. Changes or modifications to product not expressly approved by Fun Technology Innovation Inc, could void your right to use or operate your product by the FCC.

## IC statement:

### CAN ICES003 (B) / NMB003 Class (B)

This device complies with Industry Canada license exempt RSS standard(s) Operation is subject to the following two conditions:

(1) this device may not cause interference, and (2) this device must accept any interference, including interference that may cause undesired operation of the device. Cordless (Radio Transmitter) products: Section A. RSS310 (27 MHz transmitters and receivers): This Category II radio communication device complies with Industry Canada Standard RSS310. Section B. RSS210 (2.4 GHz transmitters or transceivers): This Category I radio communication device complies with RSS210 of Industry Canada.

## FunTech Innovation's Limited Hardware Product Warranty - A Summary

FunTech Innovation warrants that its hardware product shall be free from defects in materials and workmanship for the length of time identified on your product package beginning from the date of original retail purchase. See for specific warranty information about your product and procedures to act on a warranty claim.

FunTech Innovation's entire liability and your exclusive remedy for any breach of warranty shall be, at FunTech Innovation's option, to repair or replace a functional equivalent of the product, or to refund the price paid, if the hardware is returned to the point of purchase or such other place as FunTech Innovation may direct along with a receipt. Warranty protections are in addition to rights provided under local consumer laws and may vary among countries. See the full warranty information to know your consumer rights and the additional protections provided by this product warranty.









## VCCI-B

この装置は、クラスB 情報技術装置です。この装置は、家庭環境で使用することを目的としていますが、この装置がラジオやテレビジョン受信機に近接して使用されると、受信障害を引き起こすことがあります。取扱説明書に従って正しい取り扱いをしてください。

 <b>Precaution</b>	Do not use/store the product in the following • Near heat sources • Near steam or greasy smoke • Location with high humidity • Sandy or dusty places
---	--

## Safety Instruction

For your safety, please read the following instruction before you use the product. Serious injury or property damage may be caused by improper operations. Do not try to repair the product on your own.

 <b>WARNING</b>	
	Disconnect the product from power supply immediately if major failures occur. Major failures include the following: ● Smoke, peculiar smell or abnormal sound is discharged from the product. ● No image or sound is displayed, or the image error occurs. In the preceding scenarios, do not continue to use the product. Disconnect power supply immediately and contact professional staff for troubleshooting.
	Do not drop liquid, metal or anything combustible into the product. ● If any liquid or metal is dropped into the product, power off the product and disconnect power supply, then contact professional staff for solutions. ● Pay attention to children when they are close to the product.
	Put the product on a stable surface. An unstable surface includes and does not limited to an inclined plane, a shaky stand, desk or platform, which might cause turnover and damage.
	Do not open the cover or change the product on your own. High voltage components are installed in the product. When you open the cover, high voltage, electric shock, or other dangerous situations may occur. If inspection, adjustment, or maintenance is required, contact the local distributor for help.
	Use the Qualified USB Cable. ● To prevent the product from being damaged, do not use any types of USB cables other than the one provided with the product or a USB certificated cable.
	Do not put items on the top of the product. ● Do not put items, such as a container for liquid (a vase, flowerpot, cosmetics or liquid medicine) on the top of the product. ● If any water or liquid is spilled on the product, a short circuit may occur and cause fire or electric shock. ● Do not walk on or hang any items on the product.
	Do not install the product in an improper place. ● Do not install the product in humid places, such as the bathroom, the shower room, near windows, or outdoor environments that experience rain, snow or other harsh weather. Avoid installation near hot spring vapor. The preceding environments may cause faults in the product or electric shock under extreme conditions. ● Do not put exposed fire source, such as an ignited candle, on the product.
	Pull out the power plug during thunderstorms. ● Do not touch the product during a lighting storm to avoid electric shock. ● Install or place components that supply high enough voltage to cause personal injury out of the reach of children.

**⚠ WARNING**



Do not touch the power cable with wet hands.



Do not install the product in high temperature environments.

- Do not install the product near a heat source, such as a radiator, a heat reservoir, a stove or other heating products.
- Do not expose the product to direct sunlight, which may cause high temperatures and subsequent faults in the product.



For transport.

- Pack the product for transport or maintenance by using the cartons and cushioning material provided with the product.
- Vertically move the product during transport. The screen or other components are easily broken if the product is moved by an improper way.
- Before you move the product, disconnect all external connections and separate all toppling preventing products. Move the product carefully to prevent it from being hit or squeezed, especially the screen, which may cause injury if broken.



Do not cover or block up any vents on the product.

- Any overheated components may cause fire, damage the product, and shorten the service life.
- Do not lay the product down where the venting surface will be covered.
- Do not install the product on a carpet or cloth.
- Do not use a cloth such as table cloth to cover the product.



Keep away from the product when you use a radio.

The product complies with the international EMI standard to prevent radio interference. However, interference may still exist and causes noise in the radio. If noise occurs in the radio, try the following solutions.

- Adjust the direction of the radio antenna to avoid the interference from the product.
- Keep the radio away from the product.

Glass lens is broken or falls off.

- In case of glass lens breakage, keep all personnel away from the cube to ensure safety.
- Do not perform any installation or disassembly when the glass lens is broken or falls off.

Use the battery correctly.

- Galvanic corrosion, electric leakage, and even fire may be caused by improper battery usage.
- It is recommended to use the designated type of battery and install the battery by correct electrodes (positive and negative).
- Do not install and use new battery with a used one.
- Take out the battery if the remote control is not used for a long period.
- Do not expose the battery to overheated environments such as sunlight and firing.
- Dispose of the used battery based on your local regulations.



**APEX CE SPECIALISTS LIMITED**  
89 PRINCESS STREET, MANCHESTER, M1 4HT, UK



**APEX ES SPECIALISTS, S.L.**  
Calle Puerto de la Morcuera, 13, PL. 1 OF. 18-8  
28919 Leganés Madrid, Spain



**FR**

Vous êtes responsable de remettre tous les appareils électriques et électroniques usagés à des points de collecte correspondants.

Pour en savoir plus:  
[www.quefairemesdechets.fr](http://www.quefairemesdechets.fr)

For any product / warranty related question please visit  
[www.funtechinnovation.com/support](http://www.funtechinnovation.com/support)



# innex cube



Funtech  
innovation

Visit FTI website  
<https://funtechinnovation.com>

